

little tikes®

631573M

XIM631573 - 7/14

www.littletikes.com
www.littletikes.co.uk
www.littletikes.nl
www.littletikes.pl



ENG

COZY COUPE® SPORT

Ages over 1 1/2 - 5 years

Please save sales receipt for proof of purchase.

⚠ WARNING:

ADULT ASSEMBLY REQUIRED.

- Keep these instructions for future reference.
- Prior to assembly, this package contains small parts: hardware which is a choking hazard and may contain sharp edges and sharp points. Keep away from children until assembled.
- Ride-on toys should not be used near swimming pools, on or near steps, hills, roadways, or inclines.
- Shoes must be worn at all times.
- Only one rider at a time.
- Maximum weight limit: 50 lbs. (23 Kg)
- This product is intended for use by children ages over 1 1/2 - 5 years.
- Adult supervision required. Do not leave children unattended.

CONSUMER SERVICE TOLL-FREE NUMBER:

United States:

www.littletikes.com
1-800-321-0183 Monday - Friday
The Little Tikes Company
2180 Barlow Road
Hudson, OH 44236
E-mail: littletikes.cares@littletikescare.com

United Kingdom:

www.littletikes.co.uk
Little Tikes
MGA Entertainment (UK) Ltd
50 Presley Way
Crownhill
Milton Keynes MK8 0ES
Bucks, UK
E-mail: Info.LittleTikes@mgae.com



Printed in U.S.A. D.R. ©2014 The Little Tikes Company

© The Little Tikes Company, an MGA Entertainment company. LITTLE TIKES® is a trademark of Little Tikes in the U.S. and other countries. All logos, names, characters, likenesses, images, slogans, and packaging appearance are the property of Little Tikes. Please keep this address and packaging for reference since it contains important information. Contents, including specifications and colors, may vary from photos depicted on package. Instructions included. Please remove all packaging including tags, ties & tacking stitches before giving this product to a child.

LIMITED WARRANTY

The Little Tikes Company makes fun, high quality toys. We warrant to the original purchaser that this product is free of defects in materials or workmanship for one year * from the date of purchase (dated sales receipt is required for proof of purchase). At the sole election of The Little Tikes Company, the only remedies available under this warranty will be the replacement of the defective part or replacement of the product. This warranty is valid only if the product has been assembled and maintained per the instructions. This warranty does not cover abuse, accident, cosmetic issues such as fading or scratches from normal wear, or any other cause not arising from defects in material and workmanship. *The warranty period is three (3) months for daycare or commercial purchasers.

U.S.A and Canada: For warranty service or replacement part information, please visit our website at www.littletikes.com, call 1-800-321-0183 or write to: Consumer Service, The Little Tikes Company, 2180 Barlow Road, Hudson OH 44236, U.S.A. Some replacement parts may be available for purchase after warranty expires—contact us for details.

Outside U.S.A and Canada: Contact place of purchase for warranty service. This warranty gives you specific legal rights, and you may also have other rights, which vary from country/state to country/state. Some countries/states do not allow the exclusion or limitation of incidental or consequential damages, so the above limitation or exclusion may not apply to you.

Please keep this manual as it contains important information.

little tikes®

Visit our website at www.littletikes.com
to register your product online
and to enter our sweepstakes.
(No purchase necessary)

FR

COZY COUPE® SPORT

Âges : de 1 1/2 à 5 ans

Prière de conserver le reçu comme preuve d'achat.

⚠ AVERTISSEMENT:

LE MONTAGE DOIT ÊTRE EFFECTUÉ PAR UN ADULTE.

- Conserver ces instructions à titre de référence.
- Avant le montage du produit, ce paquet contient des petites pièces de matériel qui peuvent présenter un risque d'étouffement, des bords tranchants et des pointes acérées. Tenir hors de portée des enfants avant le montage complet.
- Les jouets porteurs ne doivent pas être utilisés près de piscines, sur ou près de marches, de collines, de routes ou d'endroits en pente.
- Toujours porter des chaussures.
- Un seul usager à la fois.
- Charge maximale : 23 Kg.
- Ce produit est destiné à des enfants de 1 1/2 à 5 ans.
- La surveillance par un adulte est indispensable. Ne laisser jamais un enfant sans surveillance.

SERVICE CONSOMMATEURS

www.littletikes.com

Little Tikes
MGA Entertainment Netherlands BV
klantenservice@mgae.com
Fax : +31 (0)20 659 8034



Imprimé aux États-Unis.

© The Little Tikes Company, et MGA Entertainment company. LITTLE TIKES® est une marque de commerce de Little Tikes aux États-Unis et dans d'autres pays. Tous les logos, noms, caractères, similitudes, images, slogans et apparence d'emballage sont la propriété de Little Tikes. Merci de conserver cette adresse et cet emballage car ils contiennent des informations importantes. Le contenu, y compris les spécifications et les couleurs, peut varier des illustrations de l'emballage. Instructions incluses. Merci d'enlever l'emballage, y compris les étiquettes, liens et fils cousus, avant de donner ce jouet à un enfant.

LIMITÉE GARANTIE

The Little Tikes Company fabrique des jouets amusants de qualité exceptionnelle. Nous garantissons à l'acheteur d'origine que ce produit est exempt de vices de matériel ou de fabrication pendant une année* à compter de sa date d'achat (le reçu d'achat daté est exigé comme preuve d'achat). Au titre de la présente garantie, la seule responsabilité de The Little Tikes Company et le seul recours se limitent au remplacement de la pièce défectueuse ou au remplacement du produit. La présente garantie est valable uniquement si le produit a été assemblé et entretenu conformément aux instructions fournies. La présente garantie ne couvre ni les dommages résultant d'une utilisation abusive ou d'un accident, ni l'apparence esthétique telle les décolorations ou les rayures dues à l'usage normale ou à toute autre cause ne relevant pas de vices de matériel ou de fabrication. *La période de garantie est de trois (3) mois pour les services de garderie et les acheteurs commerciaux.

États-Unis et Canada : Pour obtenir des informations sur le service de garantie ou de remplacement des pièces veuillez visiter notre site Web : www.littletikes.com, appeler le 1-800-321-0183 ou écrire à : Consumer Service, The Little Tikes Company, 2180 Barlow Road, Hudson OH 44236, U.S.A. Certaines pièces de rechange peuvent être achetées après l'expiration de la garantie – veuillez nous contacter pour obtenir de plus amples informations.

À l'extérieur des États-Unis et du Canada : Veuillez contacter le magasin où le produit a été acheté pour vous informer sur le service de garantie. La présente garantie vous offre des droits spécifiques reconnus par la loi, mais il se peut que vous ayez d'autres droits qui varient selon le pays/la province. Certains pays ou certaines provinces n'autorisent pas l'exclusion ou la limitation pour les dommages consécutifs ou fortuits, par conséquent la limitation ou l'exclusion qui précède peut ne pas s'appliquer à votre cas.

Gardez ce manuel car il renferme des renseignements importants.

little tikes®

Visitez www.littletikes.com
pour enregistrer votre produit

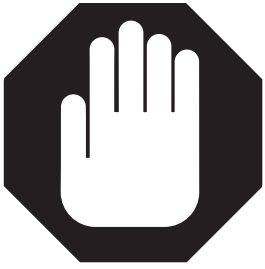

IMPORTANT: Follow steps exactly!
Certain parts of product DO NOT come apart once installed.

IMPORTANT : Suivez les étapes à la lettre !
Certaines parties de ce produit NE se détachent PAS une fois installées.

IMPORTANTE: ¡Siga los pasos con precisión!
Algunas piezas del producto NO pueden separarse una vez instaladas.

Adult assembly required

Le montage devra être effectué par un adulte / Debe ser armado por un adulto

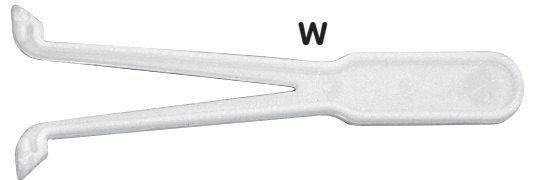
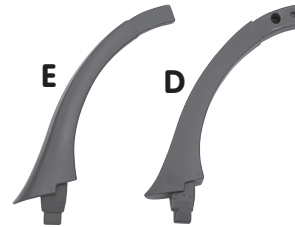
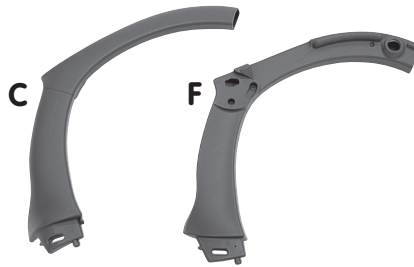
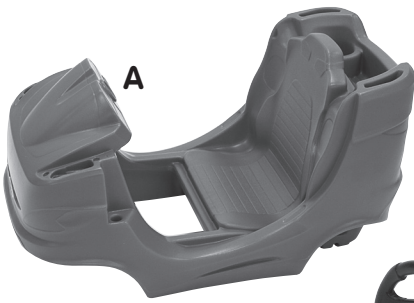
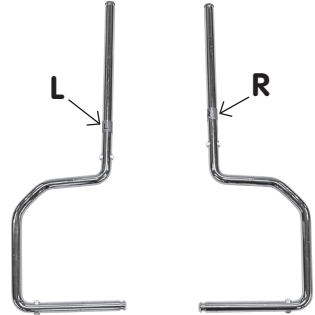

1

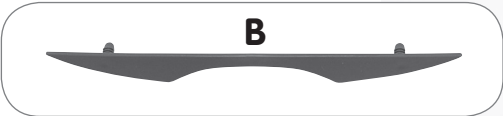

1



2



3

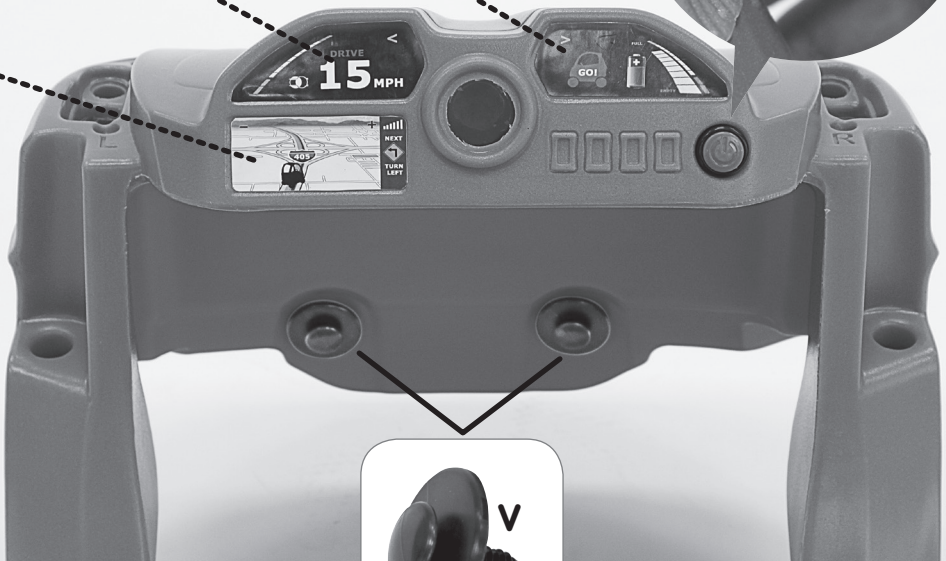



IMPORTANT: Follow steps exactly! Certain parts of product DO NOT come apart once installed.
IMPORTANT : Suivez les étapes à la lettre ! Certaines parties de ce produit NE se détachent PAS une fois installées.
IMPORTANTE: ¡Siga los pasos con precisión! Algunas piezas del producto NO pueden separarse una vez instaladas.

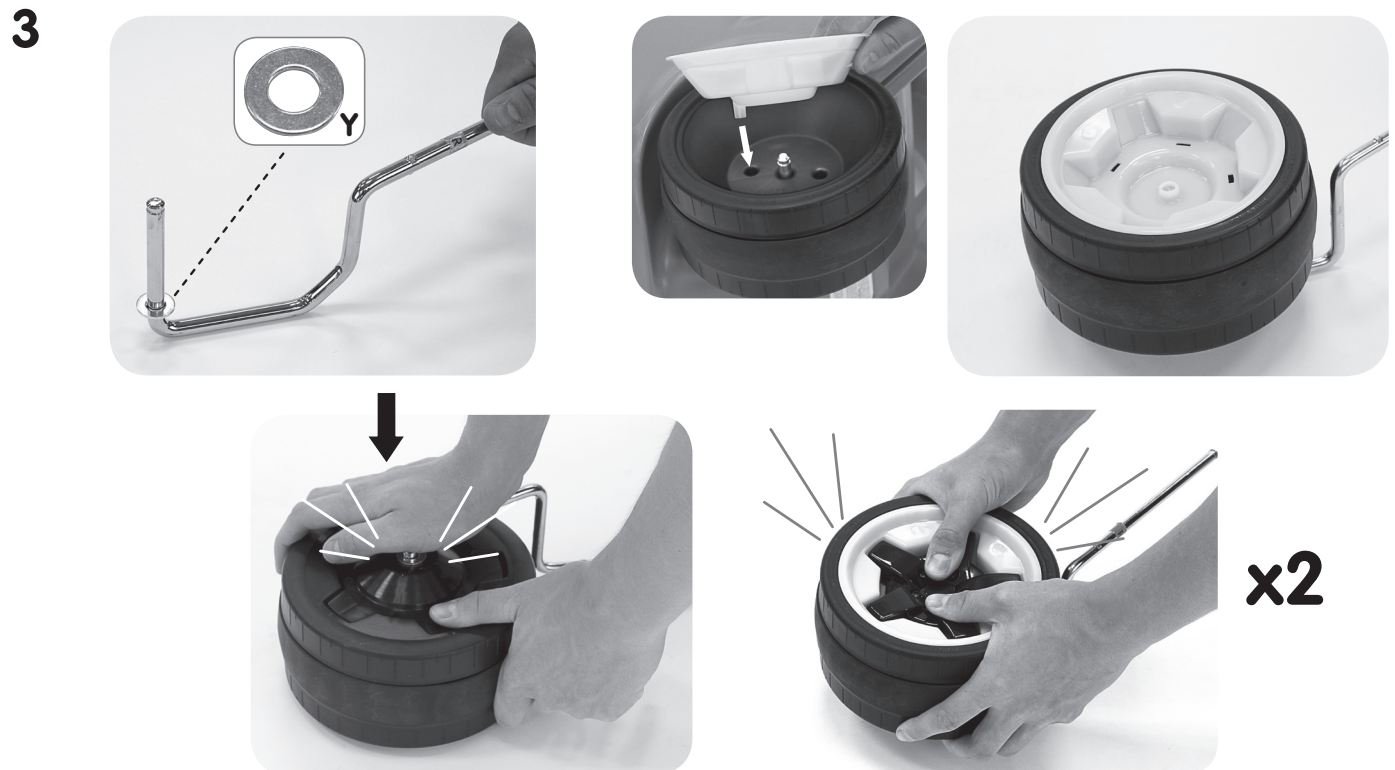

4

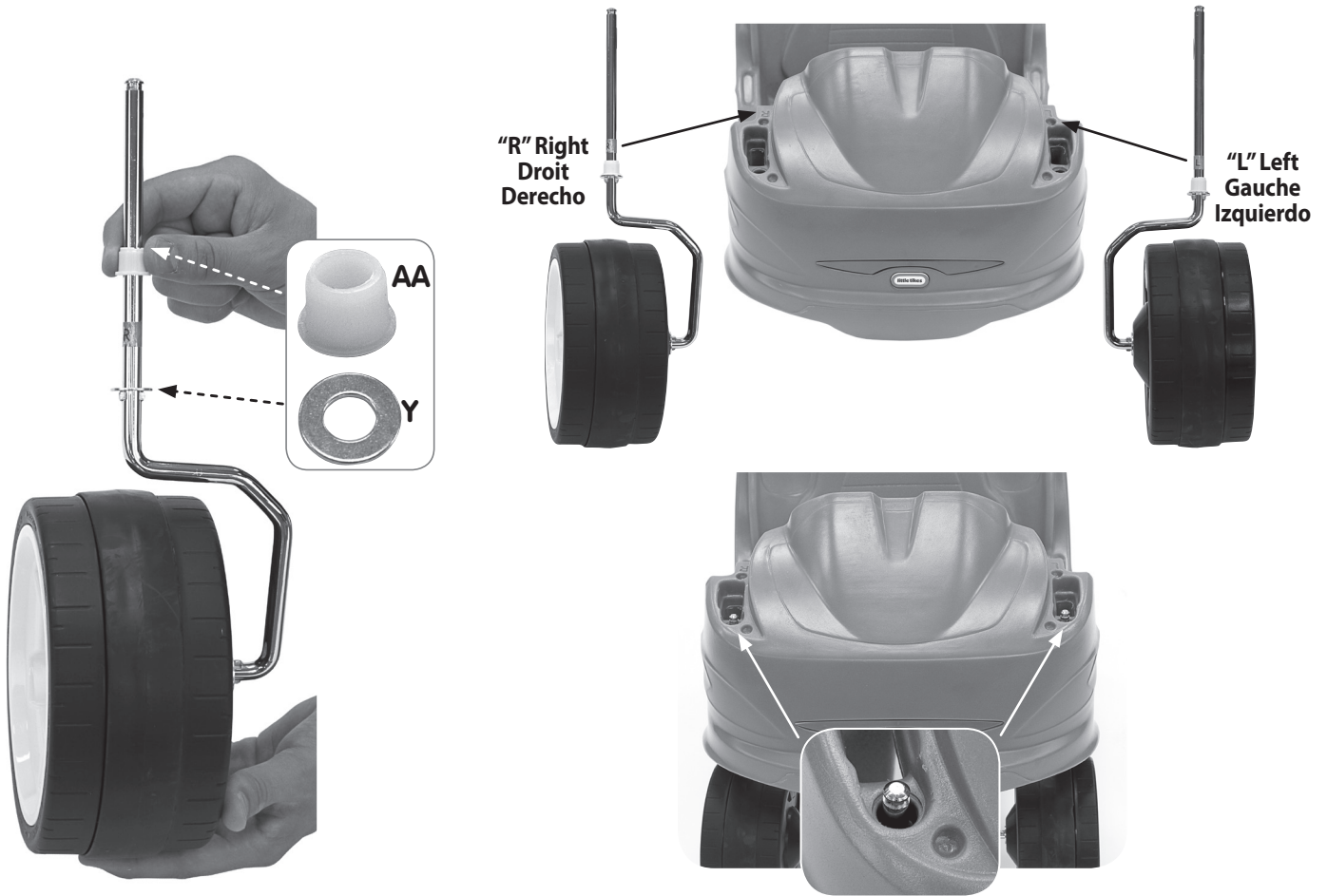

5



**IMPORTANT! Check axle positions - roll Cozy Coupe® Sport forward.
HUBCAPS SHOULD BE FACING OUTWARD.**

IMPORTANT ! Vérifiez la position des essieux : faites rouler la voiture Cozy Coupe® Sport en marche avant.

LES ENJOLIVEURS DOIVENT ÊTRE POSITIONNÉS VERS L'EXTÉRIEUR.

¡IMPORTANTE! Verifique las posiciones de los ejes. Haga rodar el carrito Cozy Coupe® Deportivo hacia adelante.

LOS TAPACUBOS DEBEN MIRAR HACIA AFUERA.



CORRECT / CORRECT / CORRECTO



WRONG / INCORRECT / INCORRECTO

6

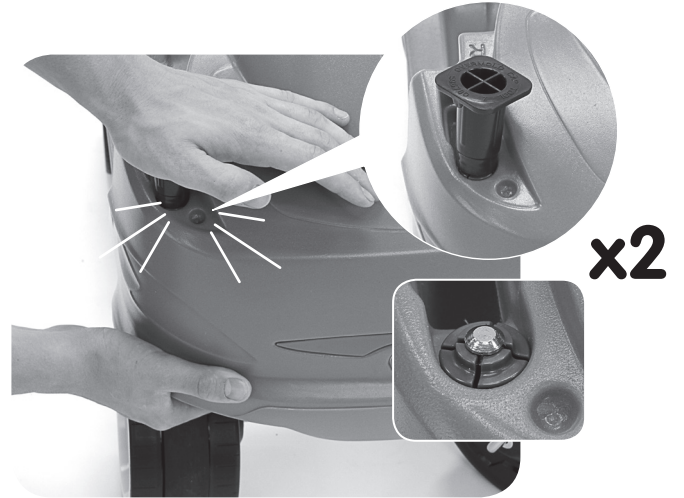
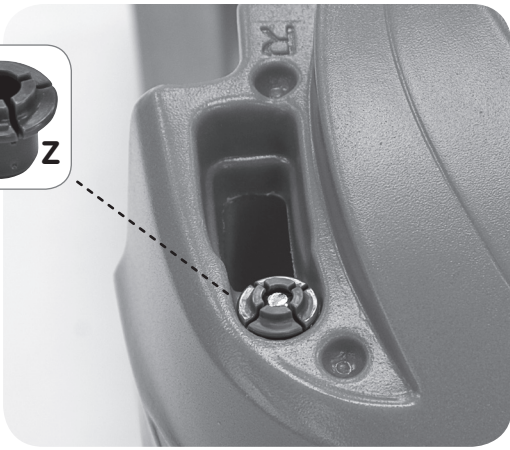

7

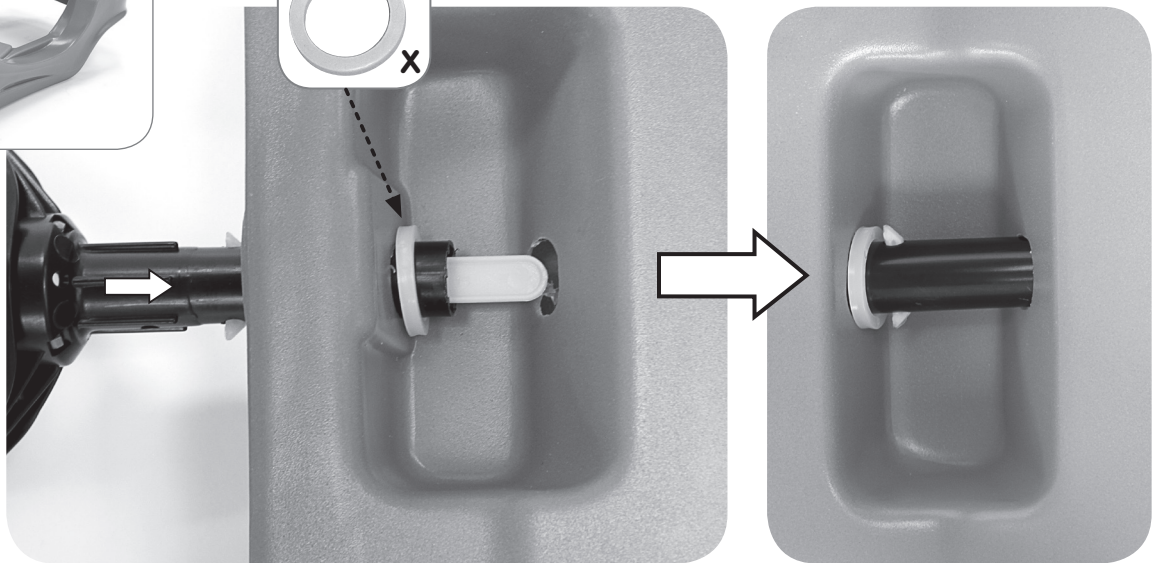
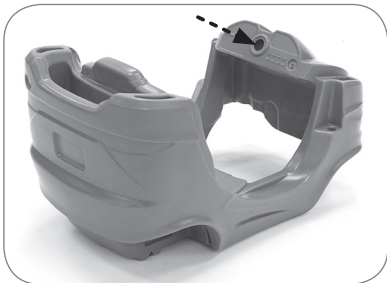
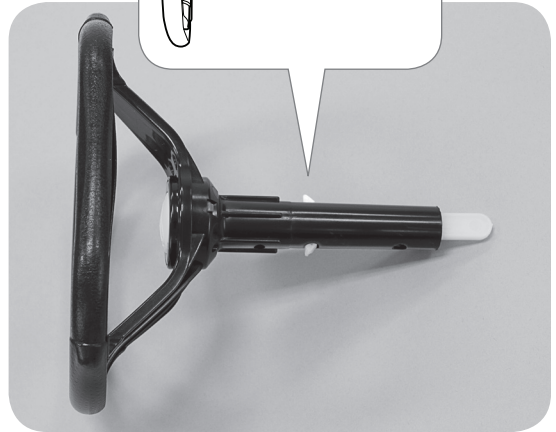
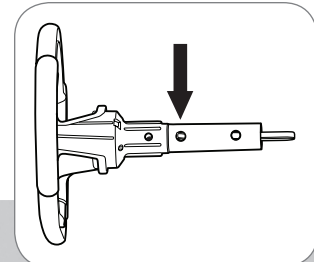
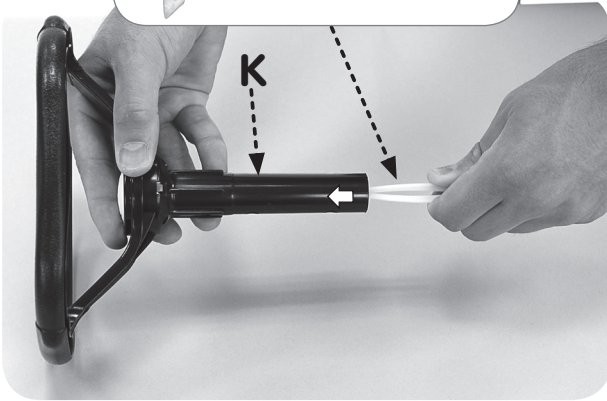
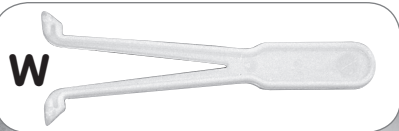

8



9

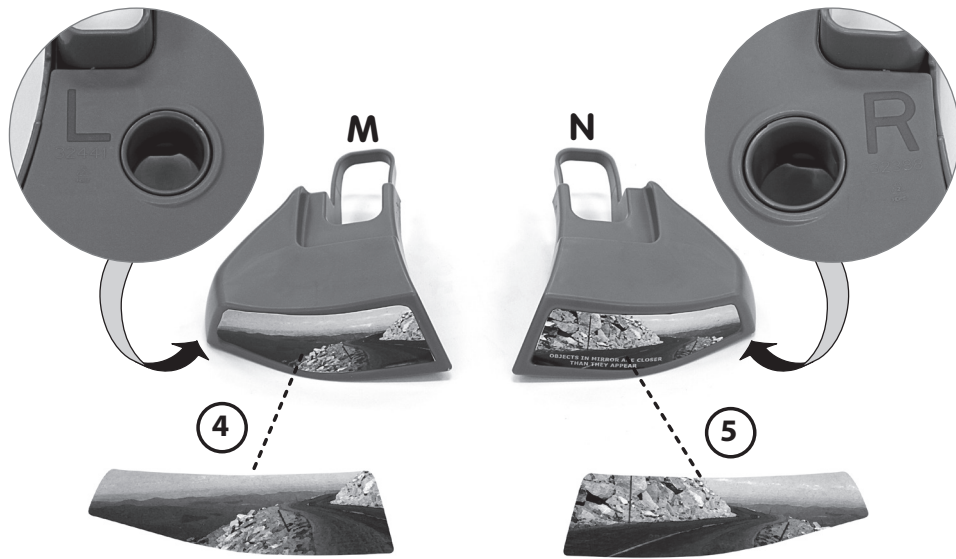

10

Assembly Hint: Before assembling pillars, coat with approx. 2-3 drops of liquid soap to area shown.

Conseil d'assemblage : Avant d'assembler les montants, enduire de 2-3 gouttes de savon liquide environ la zone indiquée.

Consejo de montaje: Antes de ensamblar los pilares, cubra los lugares indicados con aproximadamente 2 - 3 gotas de jabón líquido.

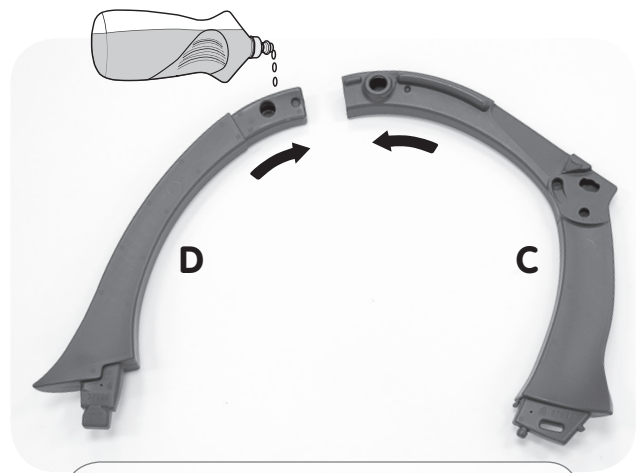
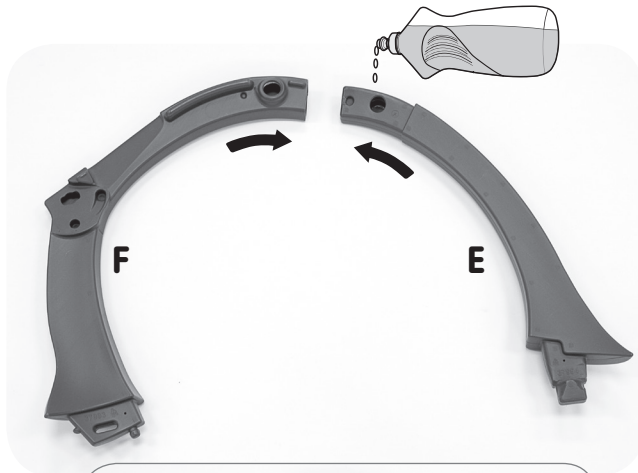

11

Assembly Hint: Before assembling pillars, coat with approx. 2-3 drops of liquid soap to area shown.

Conseil d'assemblage : Avant d'assembler les montants, enduire de 2-3 gouttes de savon liquide environ la zone indiquée.

Consejo de montaje: Antes de ensamblar los pilares, cubra los lugares indicados con aproximadamente 2 - 3 gotas de jabón líquido.

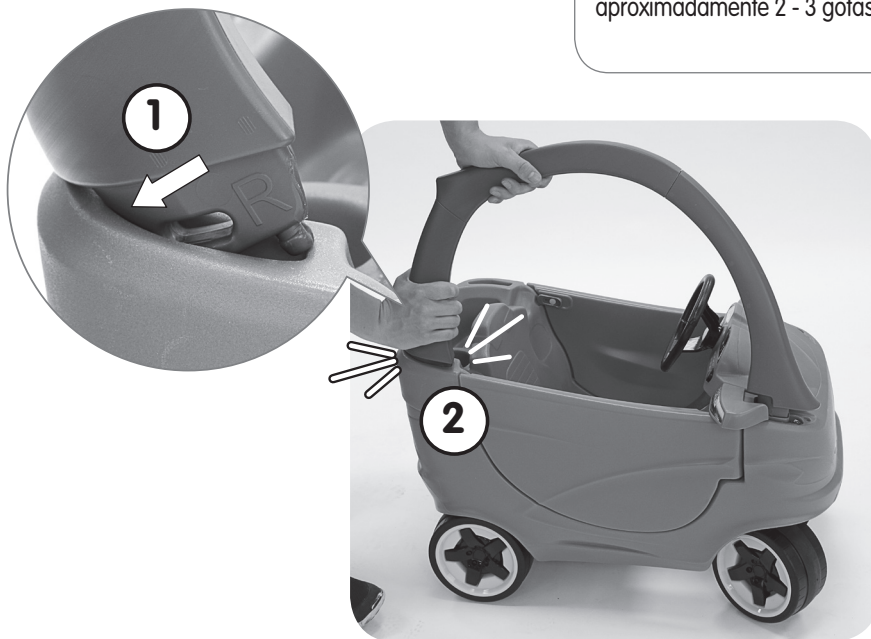
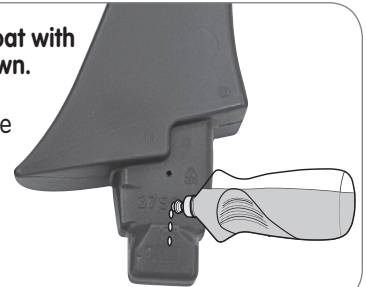

12



13



14

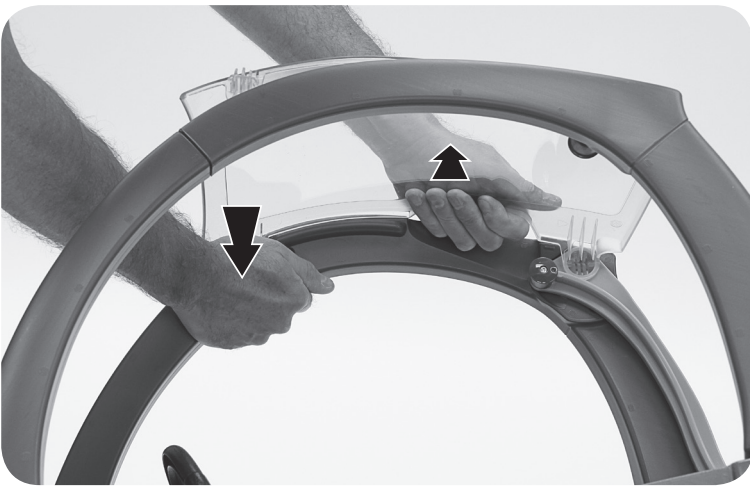

15

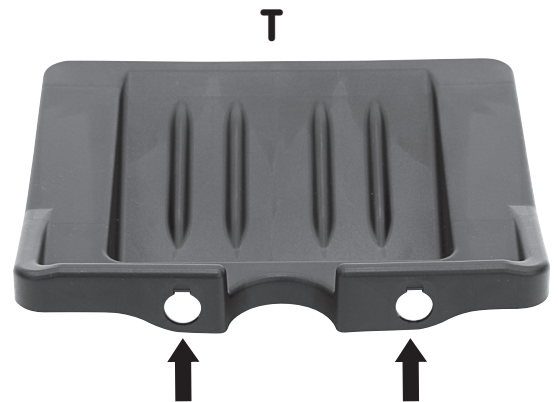
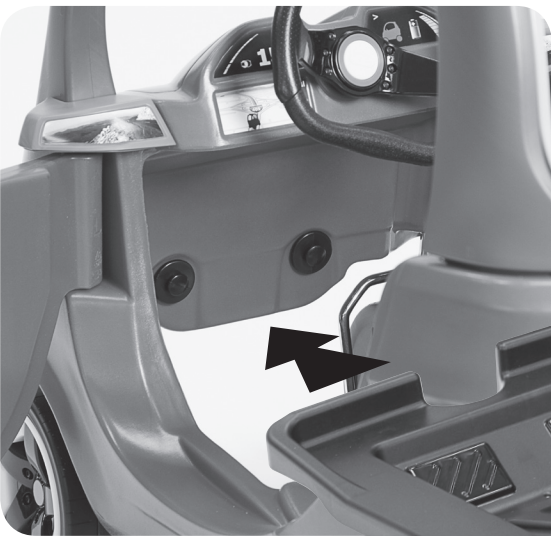

16



TO OPEN • POUR OUVRIR • PARA ABRIR



TO CLOSE • POUR FERMER • PARA CERRAR



