

FCC COMPLIANCE

NOTE: This equipment has been tested and found to comply with the limits for a Class B digital device, pursuant to Part 15 of the FCC Rules. These limits are designed to provide reasonable protection against harmful interference in a residential installation. This equipment generates, uses and can radiate radio frequency energy and, if not installed and used in accordance with the instructions, may cause harmful interference to radio communications. However, there is no guarantee that interference will not occur in a particular installation. If this equipment does cause harmful interference to radio or television reception, which can be determined by turning the equipment off and on, the user is encouraged to try to correct the interference by one or more of the following measures:

- Reorient or relocate the receiving antenna.
- Increase the separation between the equipment and receiver.
- Connect the equipment into an outlet on a circuit different from that to which the receiver is connected.
- Consult the dealer or an experienced radio/TV technician for help.

This device complies with Part 15 of the FCC Rules. Operation is subject to the following two conditions: (1) This device may not cause harmful interference, and (2) this device must accept any interference received, including interference that may cause undesired operation.

Caution: Modifications not authorized by the manufacturer may void users authority to operate this device.

This device complies with Industry Canada license-exempt RSS-210. Operation is subject to the following two conditions: (1) This device may not cause interference, and (2) This device must accept any interference, including interference that may cause undesired operation of the device.

CAN ICES-3 (B)/NMB-3(B).



'Let's care for the environment!'

The wheelie bin symbol indicates that the product must not be disposed of with other household waste.

Please use designated collection points or recycling facilities when disposing of the item.

Do not treat old batteries as household waste. Take them to a designated recycling facility.



WWW.LTXTREME.COM

Please keep this manual as it contains important information.

© The Little Tikes Company,
an MGA Entertainment company.
LTXTREME™ is a trademark of Little Tikes in the U.S. and
other countries. All logos, names, characters, likenesses,
images, slogans, and packaging appearance are the
property of Little Tikes.
Little Tikes Consumer Service
2180 Barlow Road Hudson, Ohio 44236 U.S.A.
1-800-321-0183

MGA Entertainment UK Ltd
50 Presley Way
Crownhill
Milton Keynes
MK8 0ES
Bucks, UK
0800 521 558

www.littletikes.com
www.littletikes.co.uk



0817-0-E/INT

MGA Entertainment, Inc.
16300 Roscoe Blvd.
Van Nuys,
CA 91406 U.S.A.

Printed in China



SKU: 645471

FREE-STYLE HOVERBOARD

USER GUIDE

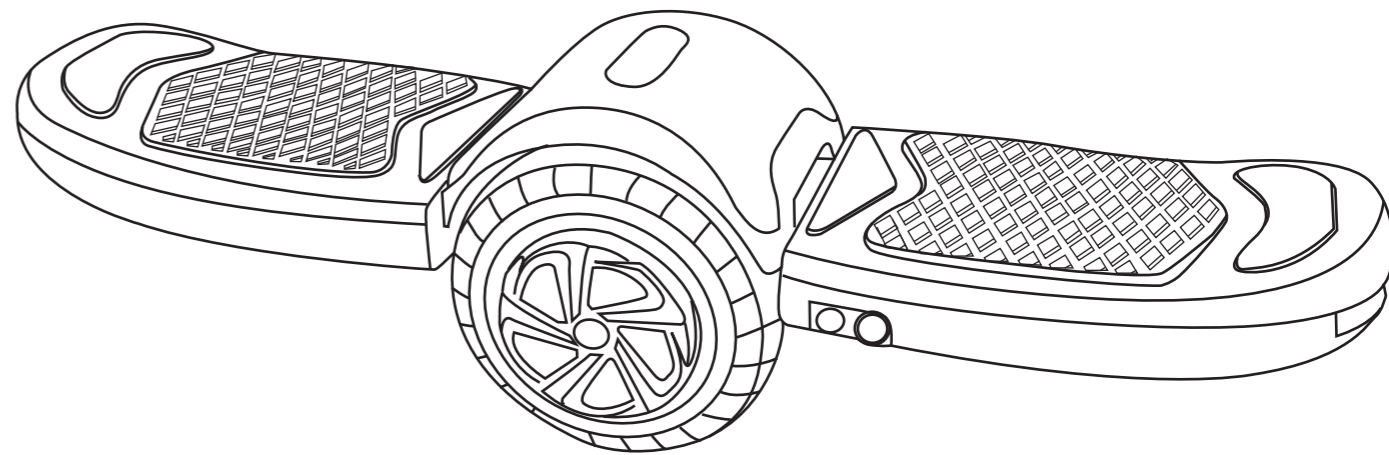

Illustrations are for reference only. Styles may vary from actual contents.

Read this entire user guide thoroughly before use to ensure a safe and fun riding experience.

**For more information, visit
www.LTXtreme.com**

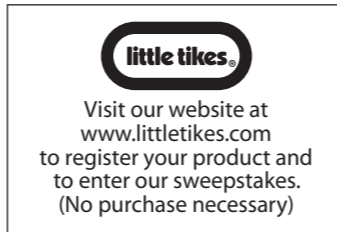

SAFETY WARNINGS

⚠️ WARNING:

READ AND FOLLOW ALL INSTRUCTIONS IN THIS USER GUIDE TO ENSURE A SAFE RIDE. Failure to read and understand all information in this user guide increases risk of injury due to falls or other incidents. Riding the hoverboard takes skill and must be learned under adult supervision. By riding this hoverboard, users risk serious injury or death from collisions, falls or loss of control.

RIDER SPECIFICATIONS

⚠️ WARNING:

NOT FOR USERS UNDER AGE 8 OR HEAVIER THAN 220 LBS (100 KG). DO NOT EXCEED THE WEIGHT LIMIT OF 220 LBS (100 KG) - including backpacks and other items that might be carried. Exceeding the weight limit could injure the rider and damage the hoverboard. Rider weight alone does not necessarily mean a person's size is appropriate to fit or maintain control of the hoverboard. Keep this product away from small children and remember that this product is only intended for use by persons who are, at minimum, comfortable and competent while operating the unit. Minimum weight for users is 55 LBS (25 KG).

Children under the age of 8 should not be permitted to use this product. The recommended age of 8 is only an estimate and can be affected by the rider's size, weight, maturity or skills - not every rider 8 years or older will be suited to the product. Any rider unable to fit comfortably on the hoverboard should not ride, **but a parent's decision to allow his or her child to ride this product should be based on the child's maturity, skill and ability to follow rules. It is emphasized that adults are strongly advised not to disregard this recommendation or permit young children to ride this unit.**

Because products like this hoverboard present potential hazards plainly associated with their use, THE NEED FOR EXERCISE OF PARENTAL RESPONSIBILITY IN SELECTING RIDING PRODUCTS APPROPRIATE TO THE AGE OF A RIDER, OR PARENTAL SUPERVISION IN SITUATIONS IN WHICH CHILDREN OF VARIOUS AGES MAY HAVE ACCESS TO THE SAME RIDING PRODUCTS, IS IMPORTANT. Not every product is appropriate for every age or size of a user, and recommendations are intended to reflect the nature of the hazards and the expected mental or physical ability, or both, of a rider to cope with the hazards.

Persons with any mental or physical conditions that may make them susceptible to injury, impair their physical dexterity or mental capabilities to recognize, understand and follow safety instructions, and/or hinder their ability to understand the hazards inherent in a product's use, should not use or be permitted to use products inappropriate for their abilities. Persons with heart conditions, head, back or neck ailments (or prior surgeries to those areas), or pregnant women should not operate this product.

⚠️ WARNING:

Riding any electric product can be a hazardous activity. Certain conditions may cause the equipment to fail without fault of the manufacturer. Like other electric ride-on products, this hoverboard is intended to move, and it is therefore possible to lose control, fall off and/or get into dangerous situations that no amount of care, instruction or expertise can eliminate. If such things occur, the user can be seriously injured or die, even when using safety equipment and other precautions. **RIDE AT YOUR OWN RISK AND USE COMMON SENSE.**

INSURANCE

⚠️ WARNING:

Your insurance policies may not provide coverage for accidents involving the use of this electric ride-on product. To determine if coverage is provided, contact your insurance company prior to use.

BATTERY AND CHARGER USAGE

⚠️ WARNING:

BATTERY INFORMATION

Check the battery charge before using the product. Do not ride the hoverboard when the battery is low, as indicated by the display on the unit. The hoverboard may stop operating and cause you to fall. Only use the included charger to charge the battery in the unit.

USING THE CHARGER

- The charger supplied with the unit should be regularly examined for damage to the cord, plug, enclosure and other parts. In the event of such damage, the product must not be charged until the charger has been replaced.
- Use caution when charging.
- The charger is not a toy. Charger should be operated by an adult.
- Do not operate the charger near flammable materials.
- Unplug charger and disconnect from product when not in use.
- Always disconnect from the charger prior to wiping down and cleaning your product with a damp cloth.

FUTURE USE AND OTHER RIDERS

⚠️ WARNING:

- Keep these instructions for future reference.
- Periodically review this information and make sure that you understand all safety warnings and instructions.
- Do not let others ride the unit until they have read this entire user guide.
- Only one rider is permitted at a time.

SAFE BATTERY USAGE

⚠️ WARNING:

The hoverboard is equipped with a lithium rechargeable battery. Please pay attention to the following cautions for safety use:

- Before recharging, allow the lithium battery in the hoverboard to cool for at least 10 minutes after use.
- Do not use the hoverboard if the battery is hot. During charging, the battery temperature should not exceed 104°F (40°C). A battery temperature that is too high or too low may indicate a problem with the battery.
- Never use the hoverboard if the battery is smoking or liquid is coming out of the battery. Do not touch any battery discharge.
- Do not dispose of the battery in fire or extreme heat.
- Do not use or leave the battery near a heat source such as a fire or a heater.
- Do not strike or throw the battery against hard surfaces.
- Do not immerse the battery in water, and keep the battery in a cool, dry place.
- When recharging, only use the battery charger specifically included for that purpose.
- Do not over-charge the battery.
- Do not directly solder the battery and pierce the battery with a nail or other sharp object.
- Do not disassemble or alter the battery.
- Charge the battery every month and as necessary.
- Do not transport or store the battery with metal objects such as necklaces, hairpins, etc.
- Please recycle a used battery after covering the battery terminals with insulation tape or inserting it into an individual poly bag. Check local laws and regulations for recycling and/or disposal information.
- Under the environment with electrostatic discharge, the product may malfunction and require the user to reset the product by turning it off and back on again.

LIMITED WARRANTY

The manufacturer warrants this product to be free of manufacturing defects for a period of 90 days from the date of purchase. This Limited Warranty does not cover normal wear and tear, tires, tubes or cables, or any damage, failure or loss caused by improper assembly, maintenance, storage or use of the LTXtreme Free-Style Hoverboard. This Limited Warranty will be void if the product is ever used in a manner other than for recreation or transportation; or modified in anyway. The manufacturer is not liable for incidental or consequential loss or damage due directly or indirectly to the use of this product.

Little Tikes does not offer an extended warranty.

For your records, save your original sales receipt with this manual, and record the product serial number on the manual for future reference.

U.S.A and Canada: For warranty service or replacement part information, please visit our website at www.littletikes.com, call 1-800-321-0183 or write to: Consumer Service, The Little Tikes Company, 2180 Barlow Road, Hudson OH 44236, U.S.A. Some replacement parts may be available for purchase after warranty expires—contact us for details.

Outside U.S.A and Canada: Contact place of purchase for warranty service. This warranty gives you specific legal rights, and you may also have other rights, which vary from country/state to country/state. Some countries/states do not allow the exclusion or limitation of incidental or consequential damages, so the above limitation or exclusion may not apply to you.

TROUBLESHOOTING

Hoverboard won't start after pushing the power button.

- The power may be too low. Charge the unit.
- Wait 3 seconds after the unit is OFF before turning ON again.
- Check that the battery voltage is normal.

Hoverboard won't self-balance.

- The power may be too low. Charge the unit.
- Wait 3 seconds after the unit is OFF before turning ON again.

Hoverboard won't turn OFF.

- Press and hold the power button several times.
- Charge the vehicle for awhile. Then, press the power button to try again.

Wireless connection fails.

- Turn the device OFF and back ON.
- Turn OFF the hoverboard and back ON again.

Hoverboard won't play music.

- Ensure you are using a compatible device.
- A list of compatible devices can be found at: littletikes.com/freestyle
- Be sure your device is ON and connected.
- Be sure your hoverboard is ON and the wireless symbol is illuminated.

CLEANING AND STORAGE

WARNING: Prolonged exposure to UV rays, rain and the elements may damage the enclosure materials. Store indoors when not in use.

Should the unit need gentle washing due to large amounts of dirt or debris, please follow the cleaning directions below:

- 1 Prior to cleaning, always make sure the hoverboard is OFF and the charger is unplugged from the unit.
- 2 Wipe clean with a soft cloth. DO NOT use harsh chemicals or abrasive scrubs to clean.
- 3 DO NOT use a high-powered water hose or expose the unit to excessive moisture or soap. Keep all water away from the charging port and battery.
- 4 To keep your unit in good condition, wipe clean after every use.
- 5 Store the unit indoors at room temperature below 77°F (25°C) away from direct sunlight. Keep away from moisture, humid environments and harsh weather conditions. Cover the unit in its original packaging or under a covering to protect from dust and debris.
- 6 Do not place anything on top of the unit while storing. Do not store on a high shelf to prevent it from rolling off.
- 7 Store the unit after it has been fully charged. Always make sure the unit is OFF when storing. Charge at least every month when not in use to preserve the battery life.

SAFETY WARNINGS

OPERATIONAL SAFETY

WARNING:

Any type of wheeled activity can be hazardous. Wheels are intended to move and it is possible to get into dangerous situations and/or lose control and/or fall off. In such situations, serious injury or death may occur. Always be aware of activity around you. Only use the hoverboard in areas free from fixed or moving hazards. Watch your surroundings for pedestrians, animals and riders of other wheeled products or vehicles.

WARNING:

- Never operate any moving product, including this unit, under the influence of drugs or alcohol.
- Ride defensively. Watch out for potential obstacles that could catch your wheel(s) or force you to swerve suddenly or lose control. Be careful to avoid pedestrians, skaters, scooters, bikes, children and animals who may cross your path, and respect the rights and property of others.
- Never carry passengers or allow more than one person at a time to ride the product. Never hitch a ride with another product.
- Do not use headphones or a cell phone while riding.
- Always maintain a safe speed. Do not move faster than you are comfortable with, regardless of the unit's speed abilities.
- Do not make sharp turns while accelerating.
- Do not ride in reverse for extended lengths of time.
- Keep both feet on the platforms at all times while riding.
- Only use this product on completely smooth surfaces. Avoid obstacles and slippery surfaces, which could result in a loss of balance or traction and cause a fall.
- Do not ride the product in wet or icy weather. Do not immerse the product in water, as the electrical and drive components could get damaged by water or possibly create other unsafe conditions.
- Wet, slick, bumpy, uneven or rough surfaces may increase risks. Do not ride this product in mud, ice, puddles or water. Avoid excessive speeds that can be associated with downhill rides. Never use near steps or swimming pools.
- Do not ride at night or when visibility is limited.
- Be aware of your height when using the hoverboard. Be careful of door frames, branches, signs or lower obstructions.
- Be careful and know your limitations. Risk of injury increases as the degree of riding difficulty increases. The rider assumes all risk associated with aggressive riding activities.

INSPECTION BEFORE USE

WARNING:

RISK OF FIRE- No user-serviceable parts.

Always inspect the unit prior to use. Properly inspecting and maintaining this product can reduce the risk of injury. Before use, check to confirm that any and all guards or covers are in place and in good, working condition. Check that the parts are functioning properly, that the tires are not damaged or worn excessively. The unit should be maintained in accordance with the manufacturer's specifications and should not be modified from the manufacturer's original design and configurations. DO NOT open the unit, or you risk voiding the limited warranty.

HARDWARE

Before every ride, check all parts, such as nuts, bolts, fasteners, etc. to ensure they are secure and assembled correctly. There should not be any unusual rattles or sounds from loose parts or broken components. If the product is damaged, do not ride.

WHEELS

Practice riding only in wide open areas clear from curbs, parking blocks and other obstacles, including things you may fall on or into if you lose your balance. Impacting the wheels against any hard surface can damage the unit. Wheels are not covered under your limited warranty.

SAFETY GEAR AND ATTIRE

Always wear proper protective equipment, such as an approved safety helmet (with chin strap securely buckled). A helmet may be legally required by local law or regulation in your area. Elbow pads, kneepads, wrist guards, a long-sleeved shirt, long pants and gloves are recommended. Always wear athletic shoes (lace-up shoes with rubber soles) and keep shoelaces tied and out of the way of the wheels, motor and drive system. Never ride barefooted or in sandals.

LOCAL LAWS OR REGULATIONS

Follow all local laws and regulations regarding how and where to use the product legally. Follow all applicable laws for vehicles and pedestrians.

TO MINIMIZE THE RISK OF INJURY, READ ALL SAFETY WARNINGS AND INSTRUCTIONS BEFORE YOU CONTINUE READING.

ABOUT YOUR HOVERBOARD

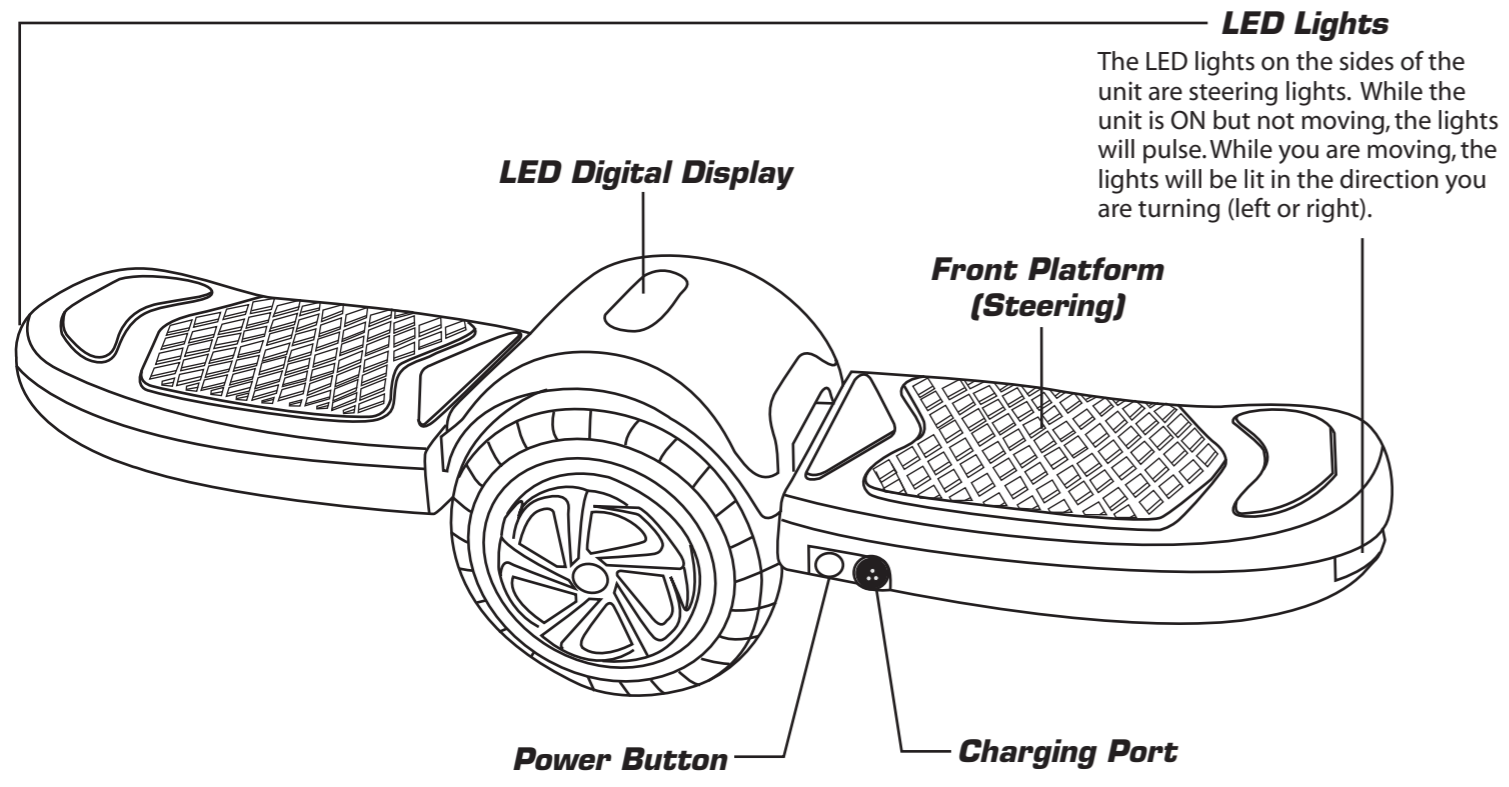

Specification Information

L x W x H	32.8 x 8.3 x 9 in. (833 x 210 x 228 mm)	Motor	BLDC
Wheel Base	5.5 in. (140 mm)	Rated Voltage	24V
Net Weight	27.7 lbs. (12.6 kg)	No Load Speed	350 rpm
Max. Load	220 lbs. (100 kg)	Rated Output	400 W
Min. Load	55 lbs. (25 kg)	Rated Output Torque	≥4N.m
Min. Ground Clearance	3 in. (78 mm)	Battery Type	LG Lithium
Tire	8 in. (203 mm)	Battery Capacity	4.3Ah
IP Rating	IPX4	Nominal Battery Voltage	29.4 V
Operating Temp.	32°-104°F (0°-40°C)	Battery Working Temp.	32°-104°F (0°-40°C)
Max Speed	7 mph (12 km/h)	Charger Input	100-240 V/AC
Range	6.2 mi. (10 km)	Charger Output	29.4V /2A
Grade Ability	≤8°	Charging Time	2-4 Hours
Turning Radius	0m	Charging Temp.	32°-104°F (0°-40°C)
Charger Manufacturer	Shenzhen Fuyuanlian Power Co., Ltd	Charger Model	FY0632942000

CHARGING INFORMATION

Your hoverboard includes a lithium battery, but the battery does not come fully charged. Before your first use and as needed, charge the battery according to the instructions below and the safety information on pages 2 and 3. Always charge the battery inside the unit in a clean, dry location away from direct sunlight, flames or sparks.

Green Bars = Charged 50-100% Battery Power	Three Yellow Bars = Charge Unit 10-50% Battery Power	Buzzer & Warning Light CHARGE IMMEDIATELY 0-10% Battery Power
--	--	---

- 1 Plug the charger into a wall outlet. The light on the charger will be green. If the green LED does not turn on, try a different outlet.
- 2 Ensure the hoverboard is turned OFF. Then, plug the charging cable into the port on the unit. The charging LED on the charger should turn red while charging. The light will turn green again when it is fully charged. Charge time is approximately 2 hours.
- 3 Unplug the charging cable from the unit and the wall outlet.
- 4 Turn the hoverboard ON when you are ready to ride.

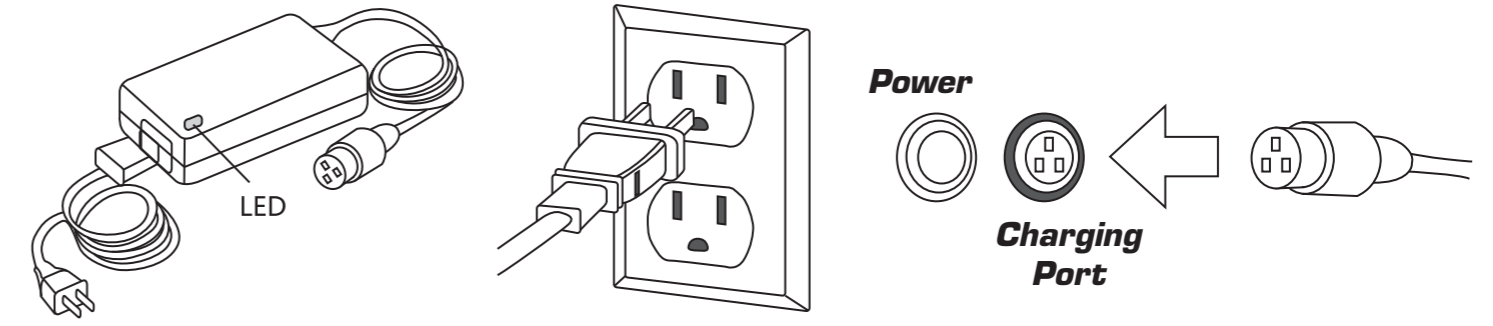

When the battery is running low or depleted, DO NOT continue driving the unit. The unit will not operate properly when the battery is too low. Continuing to ride the unit may cause injury or damage to the unit and will negatively affect the battery life.

NOTE

- When the battery is overextended for a long period of time (such as climbing a steep slope), the unit will alarm. Rider should turn around. The unit will shut down after 15 seconds.
- When the battery voltage is too low, the hoverboard will issue a buzzer alarm.
- When the battery voltage is lower than the protection mode, the system will automatically shut down after 20 seconds.

Tips

- An ADULT must charge the unit each time, as the charger is not a toy.
- Only use the included charging cable or risk voiding the limited warranty.
- Always turn the unit OFF after use to conserve battery power and maintain battery capabilities.
- Always recharge the battery after each ride and before storing. Do not overcharge.
- Ensure the charging port is completely dry before charging.
- Allow the battery to cool down before recharging.
- Keep the battery and hoverboard at room temperature when not in use. Do not use, charge or store in excessive heat, humidity or cold.
- Unplug the charging cable from the power outlet when not in use.
- Length of usage and range may vary due to riding conditions, weather, user weight and maintenance.
- Constant stopping and riding may affect the ride time.

FEATURES

LED DISPLAY

Wireless
Connection

Issue
Detected

Battery
Charge
Level



Speed

PLAY MUSIC

The icon will illuminate when wireless connection is successfully established between your device (not included) and the hoverboard. The icon light will go out when connectivity is lost or turned off.

1. Turn the hoverboard ON. The board will tell you it is waiting for wireless connection.
 2. Locate the wireless connection setting on your device (not included). Search for and select the device named "TSAX_Music."
- NOTE: The board will alert you when it successfully connects to your device.
3. Choose a song from your device.
 4. Keep the device close by as you ride to stay within the wireless range.
 5. Control your music from your device, but refrain from using your device while riding. Always come to a safe and complete stop on your hoverboard before operating another device.
- NOTE: The speaker is located under the hoverboard's front panel.
FOR A COMPLETE LIST OF COMPATIBLE DEVICES, VISIT: littletikes.com/freestyle

FAULT INDICATOR

The hoverboard will alert you when you are using the board wrong or if there is a problem. Listen for the buzzer and look for the triangle warning symbol and code on the board's LED display during use.

Issue	Code	Alert	Solution
Step On Incorrectly	E01	Buzzer	Rider should shift pedal after balancing. Buzzer will stop.
Front foot in wrong position	E02	Buzzer	Move front foot to the correct position. Buzzer will stop.
Speeding	E03	Buzzer / Board Slows	Slow Down. Buzzer will stop.
Low Battery	E04	Buzzer / Board Slows	Power off and charge. Buzzer will stop.
Insufficient Voltage	E05	Buzzer / Board Slows	Buzzer alarms for 5 sec. Unit powers off. Charge unit. Buzzer will stop.
Overcurrent	E06	Buzzer	Intermittent buzzer for 5 sec. Constant buzzer for 3 sec. Unit stops. Power off. Buzzer will stop.
Board in Wrong Position	E07	Buzzer	Buzzer alarms for 3 sec. Unit stops. Power off. Keep hoverboard in proper position. Buzzer will stop.
Internal Program Fault	E08	Buzzer / Board Slows	Buzzer alarms for 5 sec. System turns off. Power off by hand. Seek professional repair.
No response When Step On	E09	Buzzer / Board Slows	Buzzer alarms for 5 sec. System turns off. Power off by hand. Contact Consumer Service.
Motor Fault	E10	Buzzer / Board Slows	Buzzer alarms for 5 sec. System turns off. Power off by hand. Contact Consumer Service.
Gyroscope Fault	E11	Buzzer / Board Slows	Buzzer alarms for 5 sec. System turns off. Power off by hand. Contact Consumer Service.
Steering Sensor Fault	E12	Buzzer / Board Slows	Buzzer alarms for 5 sec. System turns off. Power off by hand. Contact Consumer Service.
System Fault	E13	Buzzer	Buzzer alarms. System turns off. Power off by hand. Contact Consumer Service.

BEFORE YOU BEGIN

- 1 Fully charge the hoverboard before first use (approximately 2 - 4 hours). Follow the charging instructions on page 9.
- 2 Put on all recommended protective gear.
- 3 Fully read this entire user guide before attempting to ride.
- 4 Ask a competent adult to help you stand, balance and ride until you understand how the board will move.

HOW IT WORKS

Your hoverboard has gyroscopic technology and acceleration sensors. When your body shifts positions, posture or weight distribution, the hoverboard automatically senses your movement and controls the motor to drive the board accordingly.

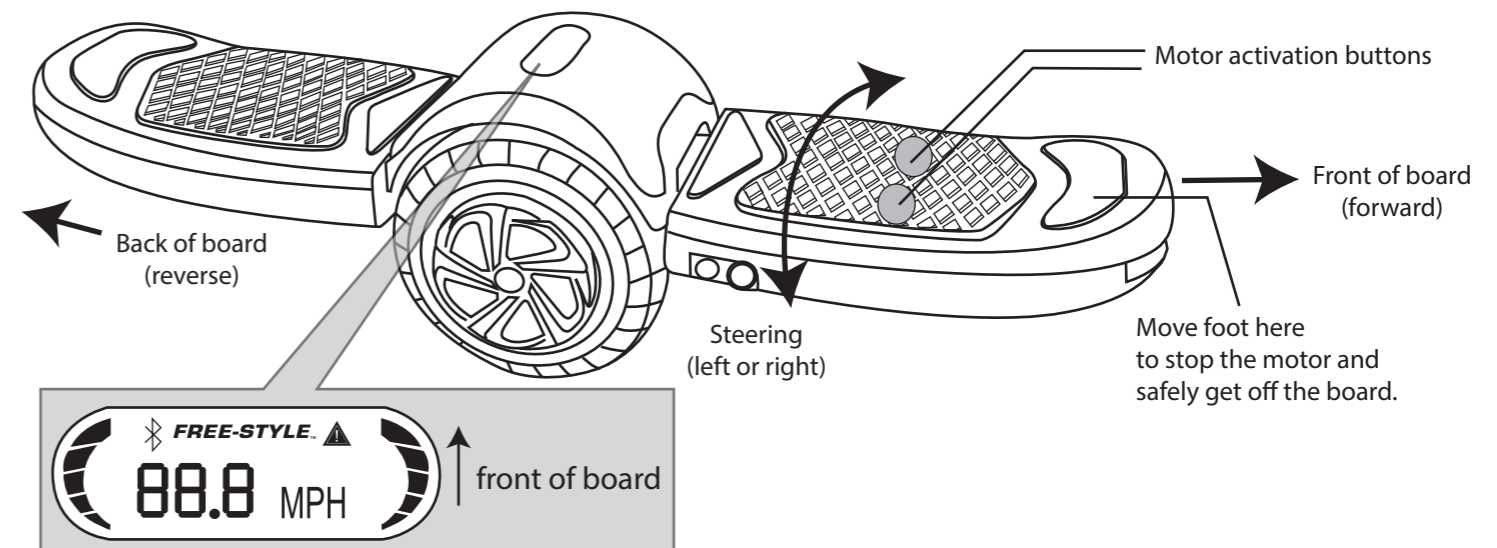

- 1 There are two motor activation buttons under the grip on the front platform. Both buttons must be pressed with your foot to move the hoverboard.
- 2 Apply pressure to the front platform or rear platform to move in that direction. The more you lean into that direction, the faster the board will accelerate.
- 3 Based on the pressure you apply with your feet and the tilted angle of the front platform, the hoverboard will turn in the direction of applied force. Apply more pressure on your front foot and tilt the front platform in the direction you want to turn (left or right).
- 4 When your body's center of gravity shifts toward the front of the board, the hoverboard will move forward and accelerate. When the center of gravity shifts backward, the board will move backward.
- 5 To slow down, simply shift your center of gravity to the opposite direction. For example, if you were leaning forward, slightly lean backward to slow down.
- 6 To brake and get off the board, move your foot off of the activation buttons on the front platform and onto the front top of the board. The platform will lower and the hoverboard will beep to let you know it's safe to step off.

NOTE The hoverboard's stability system can maintain horizontal stability of the front and rear direction, but cannot guarantee the stability of the left and right direction. Always slow down when steering with your feet to avoid injury.

DO NOT ATTEMPT TO RIDE THE HOVERBOARD UNTIL YOU UNDERSTAND HOW THE BOARD WILL MOVE BASED ON YOUR FOOT AND BODY POSITIONING.

USING YOUR HOVERBOARD

- 1** Place the hoverboard on flat terrain away from obstacles. The front pedal is what controls the unit, and it has the power button and charging port.

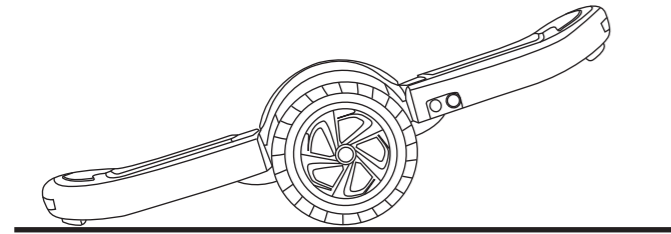

- 2** Once the hoverboard is fully charged, turn the unit ON by pressing and holding the power button until the display lights up.

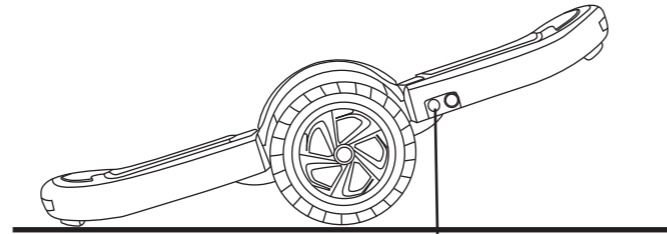

Power Button

- 3** While standing firmly on the ground, place one foot on the back pedal.

NOTE Ask a competent adult to help you stand, balance and ride or hold onto something sturdy, like railing, until you understand how the board will move.

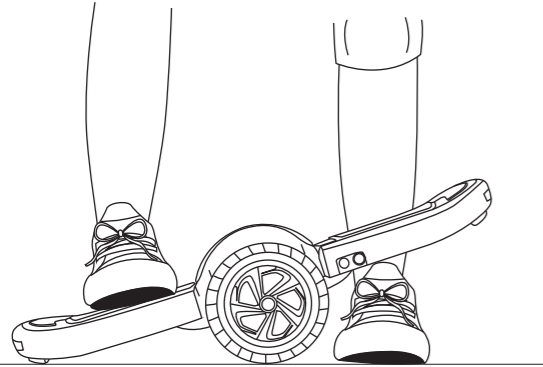

- 4** Step onto the front platform with your other foot. Try to balance the board. When it's balanced, it will beep.

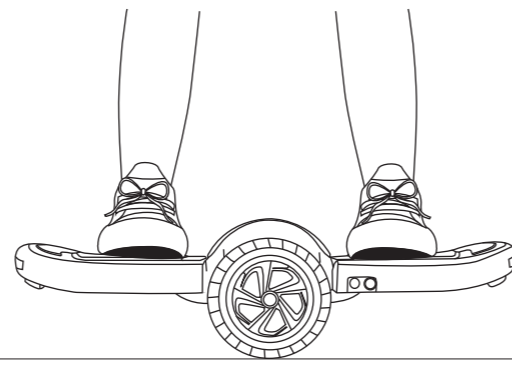

- 5** With both feet on the board try to balance your body directly over the board. Slightly lean toward the front of the board or the back of the board to get a feel for the hoverboard's movement patterns.

Always keep both feet on the platforms while riding.

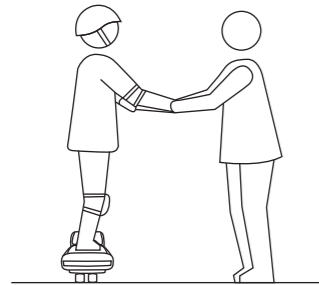

- 6** Once you can maintain balance, tilt your body toward the front of the board to shift your center of gravity. The board will move forward. Pay attention to your angle to maintain speed.

DO NOT EXCEED THE SPEED LIMIT OF 7 MPH (12 km/h). The unit will beep to remind you to maintain a safe speed.

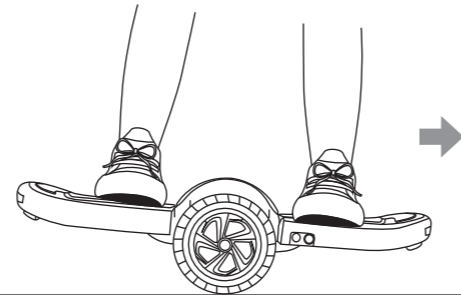

- 7** Now, try shifting your center of gravity toward the back of the board to move backward. Again, maintain a safe speed.

- 8** Always bring your body back to the center position to stop moving in either direction.

DO NOT EXCEED THE SPEED LIMIT OF 7 mph (12 km/h). The unit will beep to remind you to maintain a safe speed.

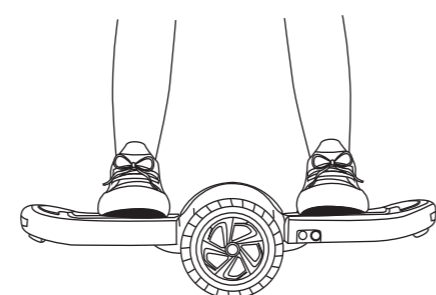
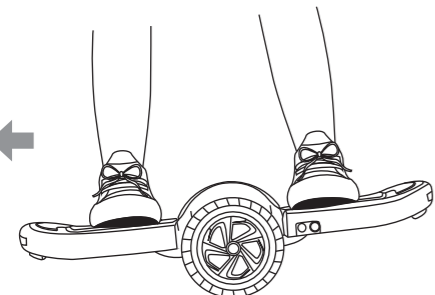

USING YOUR HOVERBOARD

DO NOT EXCEED THE SPEED LIMIT OF 7 mph (12 km/h). The unit will beep to remind you to maintain a safe speed.

- 9** Tilt the front platform with your toes or heel to turn in the direction you want to go (left or right).

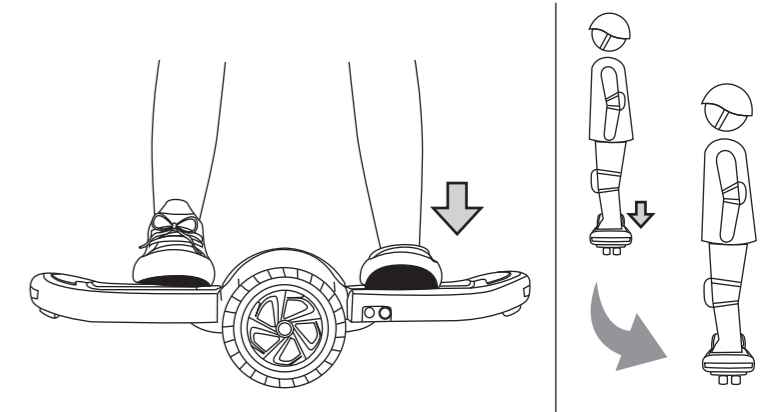
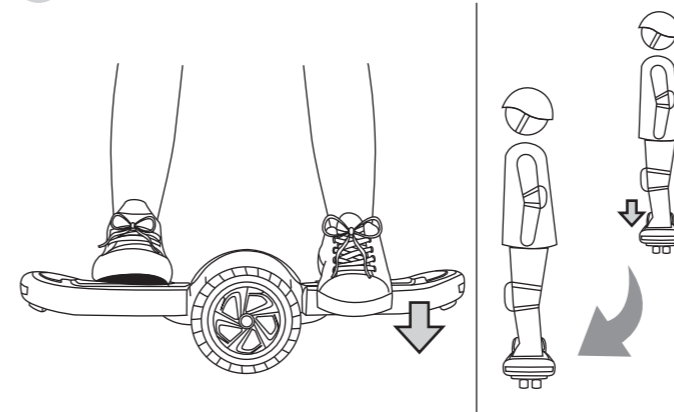

- 10** Finally, when you are ready to stop, return your body to the center position until you come to a complete stop. Move your foot to the front of the board to release the motor activation buttons.

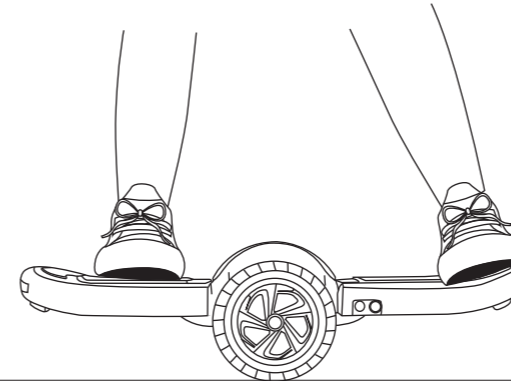

- 11** The board will beep and the front platform will lower to let you know it is safe to get off. Step off the back of the unit with your front foot. Then, step off with your back foot.

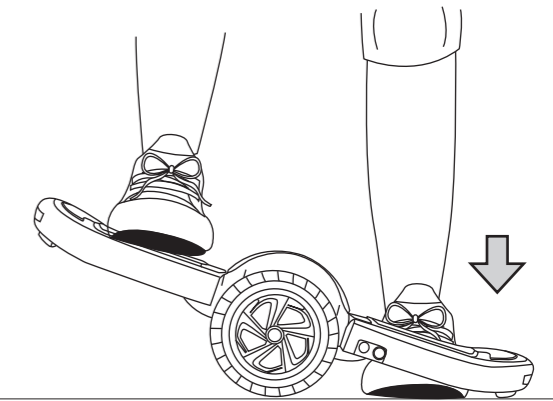

NOTE The unit does NOT brake like a car or bicycle. Sudden braking could cause the hoverboard to lose balance, and you will fall. Decelerate early and pay attention to your surroundings to come to a safe, complete stop.

- 12** Always turn the unit OFF after use. The hoverboard will beep, and the display will turn off.

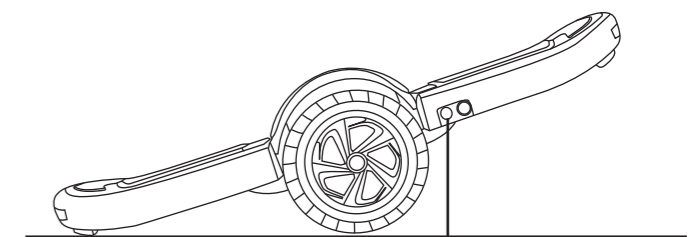

Power Button



IMPORTANT

DO NOT operate the hoverboard if the unit is improperly balanced.

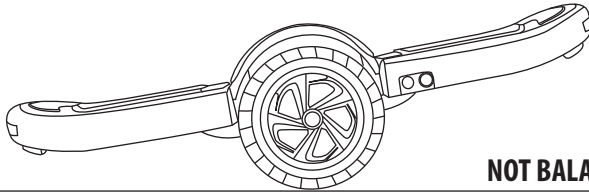

NOT BALANCED

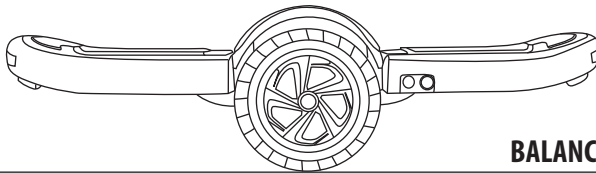
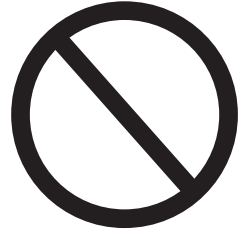

BALANCED



If the board enters balance mode at the incorrect angle, follow the steps below to rebalance the board BEFORE using it:

- 1** Turn the hoverboard OFF.
- 2** Balance the hoverboard (by hand) so that both platforms are level and parallel with the floor.
- 3** Press and hold the power button until you hear continuous beeps.
- 4** Turn the hoverboard OFF again. Then, turn the hoverboard ON. The hoverboard is now ready to use.

READ THE FULL USER GUIDE BEFORE OPERATING THIS UNIT.